

Air-Conditioners

PUHZ-RP-HA2

PUHZ-RP-HA3

INSTALLATION MANUAL

For safe and correct use, read this manual and the indoor unit installation manual thoroughly before installing the air-conditioner unit.

FOR INSTALLER

INSTALLATIONSHANDBUCH

Aus Sicherheitsgründen und zur richtigen Verwendung vor der Installation die vorliegende Bedienungsanleitung und die Installationsanleitung der Innenanlage gründlich durchlesen die Klimaanlage.

FÜR INSTALLATEURE

MANUEL D'INSTALLATION

Avant d'installer le climatiseur, lire attentivement ce manuel, ainsi que le manuel d'installation de l'appareil intérieur pour une utilisation sûre et correcte.

POUR L'INSTALLATEUR

INSTALLATIEHANDLEIDING

Lees deze handleiding en de installatiehandleiding van het binnenapparaat zorgvuldig door voordat u met het installeren van de airconditioner begint.

VOOR DE INSTALLATEUR

MANUAL DE INSTALACIÓN

Para un uso correcto y seguro, lea detalladamente este manual y el manual de instalación de la unidad interior antes de instalar la unidad de aire acondicionado.

PARA EL INSTALADOR

MANUALE DI INSTALLAZIONE

Per un uso sicuro e corretto, leggere attentamente il presente manuale ed il manuale d'installazione dell'unità interna prima di installare il condizionatore d'aria.

PER L'INSTALLATORE

ΕΓΧΕΙΡΙΔΙΟ ΟΔΗΓΙΩΝ ΕΓΚΑΤΑΣΤΑΣΗΣ

Για σωστή και ασφαλή χρήση, διαβάστε προσεκτικά αυτό το εγχειρίδιο καθώς και το εγχειρίδιο εγκατάστασης της εσωτερικής μονάδας, προτού εγκαταστήσετε τη μονάδα του κλιματιστικού

ΓΙΑ ΑΥΤΟΝ ΠΟΥ ΚΑΝΕΙ ΤΗΝ ΕΓΚΑΤΑΣΤΑΣΗ

MANUAL DE INSTALAÇÃO

Para uma utilização segura e correcta, leia atentamente este manual e o manual de instalação da unidade interior antes de instalar o aparelho de ar condicionado.

PARA O INSTALADOR

INSTALLATIONSMANUAL

Læs af sikkerhedshensyn denne manual samt manualen til installation af indendørsenheden grundigt, før du installerer klimaanlægget.

TIL INSTALLATØREN

INSTALLATIONSMANUAL

Läs bruksanvisningen och inomhusenhetens installationshandbok noga innan luftkonditioneringen installeras så att den används på ett säkert och korrekt sätt.

FÖR INSTALLATÖREN

MONTAJ ELKİTABI

Emniyetli ve doğru kullanım için, klima cihazını monte etmeden önce bu kılavuzu ve iç ünite montaj kılavuzunu tamamiyla okuyun.

MONTÖR İÇİN

РУКОВОДСТВО ПО УСТАНОВКЕ

Для обеспечения безопасной и надлежащей эксплуатации внимательно прочтите данное руководство и руководство по установке внутреннего прибора перед установкой кондиционера.

ДЛЯ УСТАНОВИТЕЛЯ**English****Deutsch****Français****Nederlands****Español****Italiano****Ελληνικά****Português****Dansk****Svenska****Türkçe****Русский**

Contents

1. Safety precautions.....	2	6. Electrical work	8
2. Installation location	3	7. Test run.....	9
3. Installing the outdoor unit	4	8. Initial settings for refrigerant leakage detection function	9
4. Installing the refrigerant piping	5	9. Special Functions	10
5. Drainage piping work.....	7	10. System control (Fig. 10-1).....	10

1. Safety precautions

- ▶ Before installing the unit, make sure you read all the “Safety precautions”.
- ▶ Please report to or take consent by the supply authority before connection to the system.
- ▶ Equipment complying with IEC/EN 61000-3-12 (PUHZ-RP100VHA3, PUHZ-RP125/140 VHA2)

⚠ Warning:
Describes precautions that must be observed to prevent danger of injury or death to the user.

⚠ Caution:
Describes precautions that must be observed to prevent damage to the unit.

- ⚠ Warning:**
- The unit must not be installed by the user. Ask a dealer or an authorized technician to install the unit. If the unit is installed incorrectly, water leakage, electric shock, or fire may result.
 - For installation work, follow the instructions in the Installation Manual and use tools and pipe components specifically made for use with R410A refrigerant. The R410A refrigerant in the HFC system is pressurized 1.6 times the pressure of usual refrigerants. If pipe components not designed for R410A refrigerant are used and the unit is not installed correctly, the pipes may burst and cause damage or injuries. In addition, water leakage, electric shock, or fire may result.
 - The unit must be installed according to the instructions in order to minimize the risk of damage from earthquakes, typhoons, or strong winds. An incorrectly installed unit may fall down and cause damage or injuries.
 - The unit must be securely installed on a structure that can sustain its weight. If the unit is mounted on an unstable structure, it may fall down and cause damage or injuries.
 - If the air conditioner is installed in a small room, measures must be taken to prevent the refrigerant concentration in the room from exceeding the safety limit in the event of refrigerant leakage. Consult a dealer regarding the appropriate measures to prevent the allowable concentration from being exceeded. Should the refrigerant leak and cause the concentration limit to be exceeded, hazards due to lack of oxygen in the room may result.
 - Ventilate the room if refrigerant leaks during operation. If refrigerant comes into contact with a flame, poisonous gases will be released.
 - All electric work must be performed by a qualified technician according to local regulations and the instructions given in this manual. The units must be powered by dedicated power lines and the correct voltage and circuit breakers must be used. Power lines with insufficient capacity or incorrect electrical work may result in electric shock or fire.

After installation work has been completed, explain the “Safety Precautions,” use, and maintenance of the unit to the customer according to the information in the Operation Manual and perform the test run to ensure normal operation. Both the Installation Manual and Operation Manual must be given to the user for keeping. These manuals must be passed on to subsequent users.

⚡ : Indicates a part which must be grounded.

⚠ Warning:
Carefully read the labels affixed to the main unit.

- Use C1220 copper phosphorus, for copper and copper alloy seamless pipes, to connect the refrigerant pipes. If the pipes are not connected correctly, the unit will not be properly grounded and electric shock may result.
- Use only specified cables for wiring. The connections must be made securely without tension on the terminals. If the cables are connected or installed incorrectly, overheating or fire may result.
- The terminal block cover panel of the outdoor unit must be firmly attached. If the cover panel is mounted incorrectly and dust and moisture enter the unit, electric shock or fire may result.
- When installing or moving the air conditioner, use only the specified refrigerant (R410A) to charge the refrigerant lines. Do not mix it with any other refrigerant and do not allow air to remain in the lines. Air enclosed in the lines can cause pressure peaks resulting in a rupture and other hazards.
- Use only accessories authorized by Mitsubishi Electric and ask a dealer or an authorized technician to install them. If accessories are incorrectly installed, water leakage, electric shock, or fire may result.
- Do not alter the unit. Consult a dealer for repairs. If alterations or repairs are not performed correctly, water leakage, electric shock, or fire may result.
- The user should never attempt to repair the unit or transfer it to another location. If the unit is installed incorrectly, water leakage, electric shock, or fire may result. If the air conditioner must be repaired or moved, ask a dealer or an authorized technician.
- After installation has been completed, check for refrigerant leaks. If refrigerant leaks into the room and comes into contact with the flame of a heater or portable cooking range, poisonous gases will be released.

1.1. Before installation

- ⚠ Caution:**
- Do not use the unit in an unusual environment. If the air conditioner is installed in areas exposed to steam, volatile oil (including machine oil), or sulfuric gas, areas exposed to high salt content such as the seaside, or areas where the unit will be covered by snow, the performance can be significantly reduced and the internal parts can be damaged.
 - Do not install the unit where combustible gases may leak, be produced, flow, or accumulate. If combustible gas accumulates around the unit, fire or explosion may result.
 - The outdoor unit produces condensation during the heating operation. Make sure to provide drainage around the outdoor unit if such condensation is likely to cause damage.

- When installing the unit in a hospital or communications office, be prepared for noise and electronic interference. Inverters, home appliances, high-frequency medical equipment, and radio communications equipment can cause the air conditioner to malfunction or breakdown. The air conditioner may also affect medical equipment, disturbing medical care, and communications equipment, harming the screen display quality.

1.2. Before installation (relocation)

- ⚠ Caution:**
- Be extremely careful when transporting the units. Two or more persons are needed to handle the unit, as it weighs 20 kg or more. Do not grasp the packaging bands. Wear protective gloves to remove the unit from the packaging and to move it, as you can injure your hands on the fins or other parts.
 - Be sure to safely dispose of the packaging materials. Packaging materials, such as nails and other metal or wooden parts may cause stabs or other injuries.
 - The base and attachments of the outdoor unit must be periodically checked for looseness, cracks or other damage. If such defects are left uncorrected, the unit may fall down and cause damage or injuries.

- Do not clean the air conditioner unit with water. Electric shock may result.
- Tighten all flare nuts to specification using a torque wrench. If tightened too much, the flare nut can break after an extended period and refrigerant can leak out.

1. Safety precautions

1.3. Before electric work

⚠ Caution:

- Be sure to install circuit breakers. If not installed, electric shock may result.
- For the power lines, use standard cables of sufficient capacity. Otherwise, a short circuit, overheating, or fire may result.
- When installing the power lines, do not apply tension to the cables. If the connections are loosened, the cables can snap or break and overheating or fire may result.

- Be sure to ground the unit. Do not connect the ground wire to gas or water pipes, lighting rods, or telephone grounding lines. If the unit is not properly grounded, electric shock may result.
- Use circuit breakers (ground fault interrupter, isolating switch (+B fuse), and molded case circuit breaker) with the specified capacity. If the circuit breaker capacity is larger than the specified capacity, breakdown or fire may result.

1.4. Before starting the test run

⚠ Caution:

- Turn on the main power switch more than 12 hours before starting operation. Starting operation just after turning on the power switch can severely damage the internal parts. Keep the main power switch turned on during the operation season.
- Before starting operation, check that all panels, guards and other protective parts are correctly installed. Rotating, hot, or high voltage parts can cause injuries.

- Do not touch any switch with wet hands. Electric shock may result.
- Do not touch the refrigerant pipes with bare hands during operation. The refrigerant pipes are hot or cold depending on the condition of the flowing refrigerant. If you touch the pipes, burns or frostbite may result.
- After stopping operation, be sure to wait at least five minutes before turning off the main power switch. Otherwise, water leakage or breakdown may result.

1.5. Using R410A refrigerant air conditioners

⚠ Caution:

- Use C1220 copper phosphorus, for copper and copper alloy seamless pipes, to connect the refrigerant pipes. Make sure the insides of the pipes are clean and do not contain any harmful contaminants such as sulfuric compounds, oxidants, debris, or dust. Use pipes with the specified thickness. (Refer to page 5) Note the following if reusing existing pipes that carried R22 refrigerant.
 - Replace the existing flare nuts and flare the flared sections again.
 - Do not use thin pipes. (Refer to page 5)
- Store the pipes to be used during installation indoors and keep both ends of the pipes sealed until just before brazing. (Leave elbow joints, etc. in their packaging.) If dust, debris, or moisture enters the refrigerant lines, oil deterioration or compressor breakdown may result.
- Use ester oil, ether oil, alkylbenzene oil (small amount) as the refrigeration oil applied to the flared sections. If mineral oil is mixed in the refrigeration oil, oil deterioration may result.

- Do not use refrigerant other than R410A refrigerant. If another refrigerant is used, the chlorine will cause the oil to deteriorate.
- Use the following tools specifically designed for use with R410A refrigerant. The following tools are necessary to use R410A refrigerant. Contact your nearest dealer for any questions.

Tools (for R410A)	
Gauge manifold	Flare tool
Charge hose	Size adjustment gauge
Gas leak detector	Vacuum pump adapter
Torque wrench	Electronic refrigerant charging scale

- Be sure to use the correct tools. If dust, debris, or moisture enters the refrigerant lines, refrigeration oil deterioration may result.
- Do not use a charging cylinder. If a charging cylinder is used, the composition of the refrigerant will change and the efficiency will be lowered.

2. Installation location

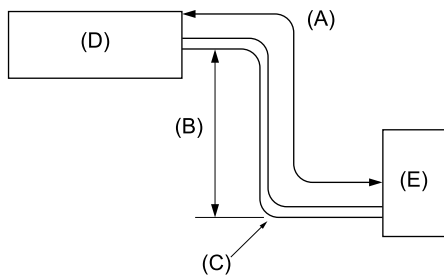
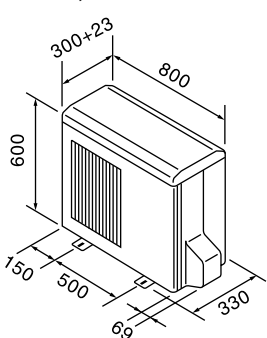

Fig. 2-1

■ RP35, 50



■ RP60-140

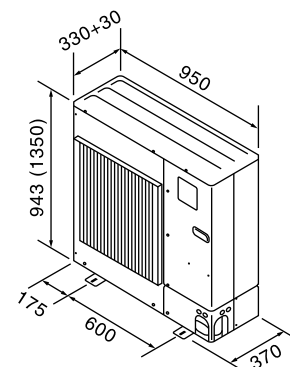

Fig. 2-2

2.1. Refrigerant pipe (Fig. 2-1)

- ▶ Check that the difference between the heights of the indoor and outdoor units, the length of refrigerant pipe, and the number of bends in the pipe are within the limits shown below.

Models	(A) Pipe length (one way)	(B) Height difference	(C) Number of bends (one way)
RP35, 50, 60, 71	Max. 50 m	Max. 30 m	Max. 15
RP100, 125, 140	Max. 75 m	Max. 30 m	Max. 15

- Height difference limitations are binding regardless of which unit, indoor or outdoor, is positioned higher.
 - (D) Indoor unit
 - (E) Outdoor unit

2.2. Choosing the outdoor unit installation location

- Avoid locations exposed to direct sunlight or other sources of heat.
- Select a location from which noise emitted by the unit will not inconvenience neighbors.
- Select a location permitting easy wiring and pipe access to the power source and indoor unit.
- Avoid locations where combustible gases may leak, be produced, flow, or accumulate.
- Note that water may drain from the unit during operation.
- Select a level location that can bear the weight and vibration of the unit.
- Avoid locations where the unit can be covered by snow. In areas where heavy snow fall is anticipated, special precautions such as raising the installation location or installing a hood on the air intake must be taken to prevent the snow from blocking the air intake or blowing directly against it. This can reduce the airflow and a malfunction may result.
- Avoid locations exposed to oil, steam, or sulfuric gas.
- Use the transportation handles of the outdoor unit to transport the unit. If the unit is carried from the bottom, hands or fingers may be pinched.

2.3. Outline dimensions (Outdoor unit) (Fig. 2-2)

The figure in parenthesis is for RP100-140 models.

2. Installation location

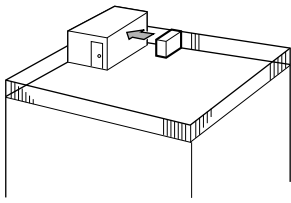

Fig. 2-3

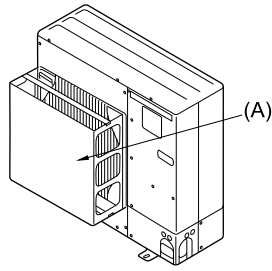

Fig. 2-4

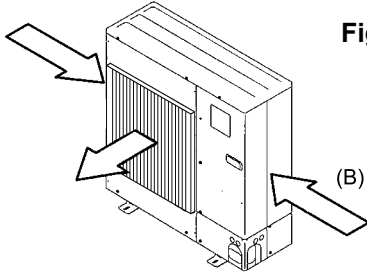

Fig. 2-5

2.4. Ventilation and service space

2.4.1. Windy location installation

When installing the outdoor unit on a rooftop or other location unprotected from the wind, situate the air outlet of the unit so that it is not directly exposed to strong winds. Strong wind entering the air outlet may impede the normal airflow and a malfunction may result. The following shows three examples of precautions against strong winds.

- (1) Face the air outlet towards the nearest available wall about 50 cm away from the wall. (Fig. 2-3)
- (2) Install an optional air guide if the unit is installed in a location where strong winds from a typhoon, etc. may directly enter the air outlet. (Fig. 2-4)
 - (A) Air guide
- (3) Position the unit so that the air outlet blows perpendicularly to the seasonal wind direction, if possible. (Fig. 2-5)
 - (B) Wind direction

2.4.2. When installing a single outdoor unit (Refer to the last page)

Minimum dimensions are as follows, except for Max., meaning Maximum dimensions, indicated.

The figures in parentheses are for RP100-140 models.

Refer to the figures for each case.

- (1) Obstacles at rear only (Fig. 2-6)
- (2) Obstacles at rear and above only (Fig. 2-7)
- (3) Obstacles at rear and sides only (Fig. 2-8)
 - * 350 for RP35, 50
- (4) Obstacles at front only (Fig. 2-9)
 - * When using an optional air outlet guide, the clearance for RP100-140 models is 500 mm or more.
- (5) Obstacles at front and rear only (Fig. 2-10)
 - * When using an optional air outlet guide, the clearance for RP100-140 models is 500 mm or more.
- (6) Obstacles at rear, sides, and above only (Fig. 2-11)
 - * 350 for RP35, 50
 - Do not install the optional air outlet guides for upward airflow.

2.4.3. When installing multiple outdoor units (Refer to the last page)

Leave 350 mm for RP35, 50 and 10 mm for RP60-140 space or more between the units.

- (1) Obstacles at rear only (Fig. 2-12)
- (2) Obstacles at rear and above only (Fig. 2-13)
 - No more than three units must be installed side by side. In addition, leave space as shown.
 - Do not install the optional air outlet guides for upward airflow.
- (3) Obstacles at front only (Fig. 2-14)
 - * When using an optional air outlet guide, the clearance for RP100-140 models is 1000 mm or more.
- (4) Obstacles at front and rear only (Fig. 2-15)
 - * When using an optional air outlet guide, the clearance for RP100-140 models is 1000 mm or more.
- (5) Single parallel unit arrangement (Fig. 2-16)
 - * When using an optional air outlet guide installed for upward airflow, the clearance is 500 (1000) mm or more.
- (6) Multiple parallel unit arrangement (Fig. 2-17)
 - * When using an optional air outlet guide installed for upward airflow, the clearance is 1000 (1500) mm or more.
- (7) Stacked unit arrangement (Fig. 2-18)
 - The units can be stacked up to two units high.
 - No more than two stacked units must be installed side by side. In addition, leave space as shown.

3. Installing the outdoor unit

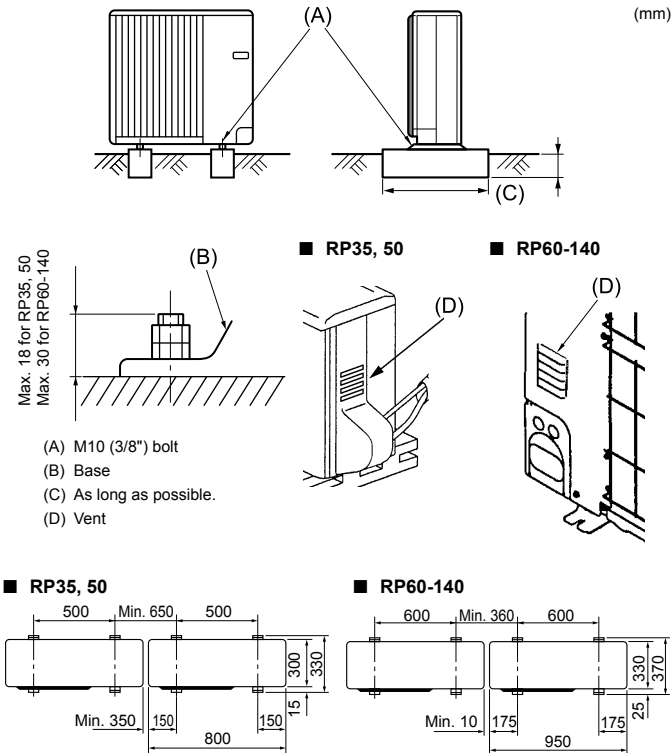

Fig. 3-1

• Be sure to install the unit in a sturdy, level surface to prevent rattling noises during operation. (Fig. 3-1)

<Foundation specifications>

Foundation bolt	M10 (3/8")
Thickness of concrete	120 mm
Length of bolt	70 mm
Weight-bearing capacity	320 kg

- Make sure that the length of the foundation bolt is within 30 mm of the bottom surface of the base.
- Secure the base of the unit firmly with four-M10 foundation bolts in sturdy locations.

Installing the outdoor unit

- Do not block the vent. If the vent is blocked, operation will be hindered and breakdown may result.
- In addition to the unit base, use the installation holes on the back of the unit to attach wires, etc., if necessary to install the unit. Use self-tapping screws ($\varnothing 5 \times 15$ mm or more) and install on site.

⚠ Warning:

- **The unit must be securely installed on a structure that can sustain its weight. If the unit is mounted on an unstable structure, it may fall down and cause damage or injuries.**
- **The unit must be installed according to the instructions in order to minimize the risk of damage from earthquakes, typhoons, or strong winds. An incorrectly installed unit may fall down and cause damage or injuries.**

4. Installing the refrigerant piping

4.1. Precautions for devices that use R410A refrigerant

- Refer to page 3 for precautions not included below on using air conditioners with R410A refrigerant.
- Use ester oil, ether oil, alkylbenzene oil (small amount) as the refrigeration oil applied to the flared sections.
- Use C1220 copper phosphorus, for copper and copper alloy seamless pipes, to connect the refrigerant pipes. Use refrigerant pipes with the thicknesses specified in the table to the below. Make sure the insides of the pipes are clean and do not contain any harmful contaminants such as sulfuric compounds, oxidants, debris, or dust.

⚠ Warning:

When installing or moving the air conditioner, use only the specified refrigerant (R410A) to charge the refrigerant lines. Do not mix it with any other refrigerant and do not allow air to remain in the lines. Air enclosed in the lines can cause pressure peaks resulting in a rupture and other hazards.

	RP35, 50	RP60-140
Liquid pipe	ø6.35 thickness 0.8 mm	ø9.52 thickness 0.8 mm
Gas pipe	ø12.7 thickness 0.8 mm	ø15.88 thickness 1.0 mm

- Do not use pipes thinner than those specified above.

4.2. Connecting pipes (Fig. 4-1)

- When commercially available copper pipes are used, wrap liquid and gas pipes with commercially available insulation materials (heat-resistant to 100°C or more, thickness of 12 mm or more).
- The indoor parts of the drain pipe should be wrapped with polyethylene foam insulation materials (specific gravity of 0.03, thickness of 9 mm or more).
- Apply thin layer of refrigerant oil to pipe and joint seating surface before tightening flare nut. (A)
- Use two wrenches to tighten piping connections. (B)
- Use leak detector or soapy water to check for gas leaks after connections are completed.
- Apply refrigerating machine oil over the entire flare seat surface. (C)
- Use the flare nuts for the following pipe size. (D)

		RP35, 50	RP60, 71	RP100-140
Gas side	Pipe size (mm)	ø12.7	ø15.88	ø15.88
Liquid side	Pipe size (mm)	ø6.35	ø9.52	ø9.52

- When bending the pipes, be careful not to break them. Bend radii of 100 mm to 150 mm are sufficient.
- Make sure the pipes do not contact the compressor. Abnormal noise or vibration may result.

- Pipes must be connected starting from the indoor unit.
Flare nuts must be tightened with a torque wrench.
 - Flare the liquid pipes and gas pipes and apply a thin layer of refrigeration oil (Applied on site).
- When usual pipe sealing is used, refer to Table 1 for flaring of R410A refrigerant pipes.
The size adjustment gauge can be used to confirm A measurements.

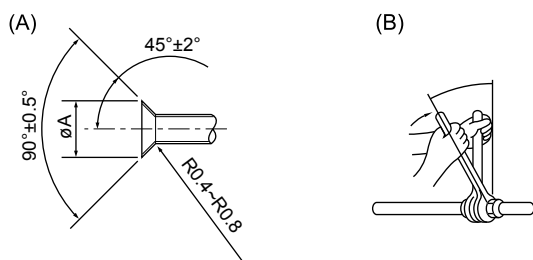

(A) Flare cutting dimensions
(B) Flare nut tightening torque

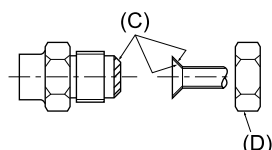

Fig. 4-1

(A) (Fig. 4-1)

Copper pipe O.D. (mm)	Flare dimensions øA dimensions (mm)
ø6.35	8.7 - 9.1
ø9.52	12.8 - 13.2
ø12.7	16.2 - 16.6
ø15.88	19.3 - 19.7
ø19.05	23.6 - 24.0

(B) (Fig. 4-1)

Copper pipe O.D. (mm)	Flare nut O.D. (mm)	Tightening torque (N·m)
ø6.35	17	14 - 18
ø6.35	22	34 - 42
ø9.52	22	34 - 42
ø12.7	26	49 - 61
ø12.7	29	68 - 82
ø15.88	29	68 - 82
ø15.88	36	100 - 120
ø19.05	36	100 - 120

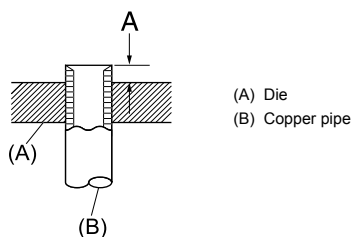

Fig. 4-2

Table 1 (Fig. 4-2)

Copper pipe O.D. (mm)	A (mm)	
	Flare tool for R410A	Flare tool for R22·R407C
	Clutch type	
ø6.35 (1/4")	1.0 - 1.5	0 - 0.5
ø9.52 (3/8")	1.0 - 1.5	0 - 0.5
ø12.7 (1/2")	1.0 - 1.5	0 - 0.5
ø15.88 (5/8")	1.0 - 1.5	0 - 0.5
ø19.05 (3/4")	1.0 - 1.5	0 - 0.5

4. Installing the refrigerant piping

■ RP35, 50

■ RP60-140

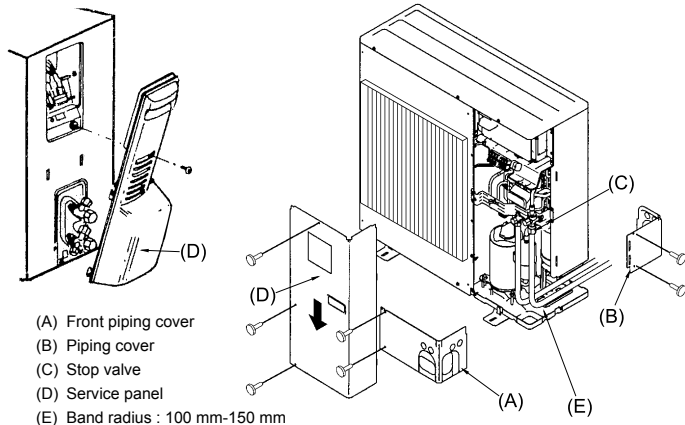

Fig. 4-3

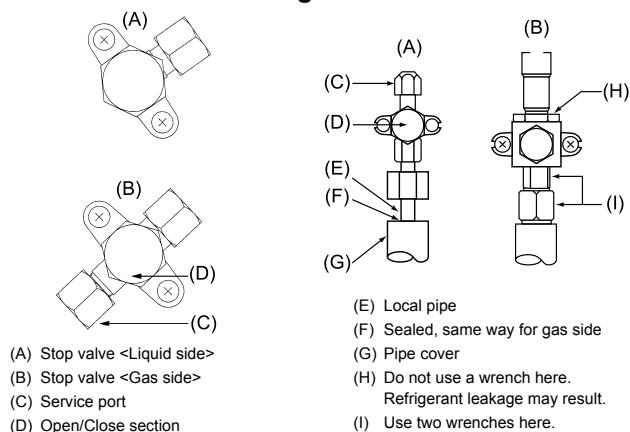

Fig. 4-4

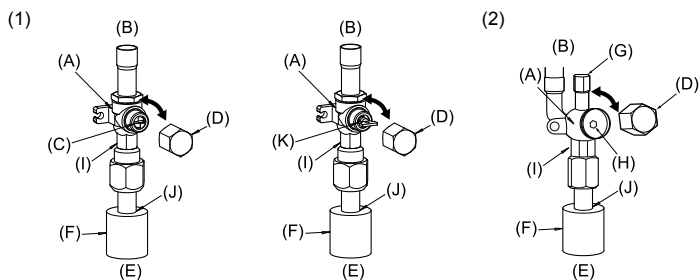

Fig. 4-5

Fig. 4-6

- (A) Valve
 (B) Unit side
 (C) Operation section
 (D) Cap
 (E) Local pipe side
 (F) Pipe cover
 (G) Service port
 (H) Wrench hole
- (I) Double spanner section
 (Do not apply a spanner other than to this section.
 Doing so would cause coolant leaks.)
 (J) Seal section
 (Seal the end of the heat insulation material at
 the pipe connection seal section with whatever seal
 material you have on hand so that water does not
 infiltrate the heat insulation material.)
 (K) Handle

4.3. Refrigerant piping (Fig. 4-3)

■ For RP35, 50

Remove the service panel (D) (one screw).

■ For RP60-140

Remove the service panel (D) (three screws) and the front piping cover (A) (two screws) and rear piping cover (B) (two screws).

- Perform refrigerant piping connections for the indoor/outdoor unit when the outdoor unit's stop valve is completely closed.
- Vacuum-purge air from the indoor unit and the connection piping.
- After connecting the refrigerant pipes, check the connected pipes and the indoor unit for gas leaks. (Refer to 4.4 Refrigerant pipe airtight testing method)

- A high-performance vacuum pump is used at the stop valve service port to maintain a vacuum for an adequate time (at least one hour after reaching -101 kPa (5 Torr)) in order to vacuum dry the inside of the pipes. Always check the degree of vacuum at the gauge manifold. If there is any moisture left in the pipe, the degree of vacuum is sometimes not reached with short-time vacuum application.

After vacuum drying, completely open the stop valves (both liquid and gas) for the outdoor unit. This completely links the indoor and outdoor coolant circuits.

- If the vacuum drying is inadequate, air and water vapor remain in the coolant circuits and can cause abnormal rise of high pressure, abnormal drop of low pressure, deterioration of the freezing machine oil due to moisture, etc.
- If the stop valves are left closed and the unit is operated, the compressor and control valves will be damaged.

- Use a leak detector or soapy water to check for gas leaks at the pipe connection sections of the outdoor unit.
- Do not use the refrigerant from the unit to purge air from the refrigerant lines.

- After the valve work is completed, tighten the valve caps to the correct torque: 20 to 25 N·m (200 to 250 kgf·cm).

Failure to replace and tighten the caps may result in refrigerant leakage. In addition, do not damage the insides of the valve caps as they act as a seal to prevent refrigerant leakage.

- Use sealant to seal the ends of the thermal insulation around the pipe connection sections to prevent water from entering the thermal insulation.

4.4. Refrigerant pipe airtight testing method (Fig. 4-4)

- Connect the testing tools.

- Make sure the stop valves (A) (B) are closed and do not open them.
- Add pressure to the refrigerant lines through the service port (C) of the liquid stop valve (D).

- Do not add pressure to the specified pressure all at once; add pressure little by little.
 - Pressurize to 0.5 MPa (5 kgf/cm²G), wait five minutes, and make sure the pressure does not decrease.
 - Pressurize to 1.5 MPa (15 kgf/cm²G), wait five minutes, and make sure the pressure does not decrease.
 - Pressurize to 4.15 MPa (41.5 kgf/cm²G) and measure the surrounding temperature and refrigerant pressure.

- If the specified pressure holds for about one day and does not decrease, the pipes have passed the test and there are no leaks.
 - If the surrounding temperature changes by 1°C, the pressure will change by about 0.01 MPa (0.1 kgf/cm²G). Make the necessary corrections.

- If the pressure decreases in steps (2) or (3), there is a gas leak. Look for the source of the gas leak.

4.5. Stop valve opening method

The stop valve opening method varies according to the outdoor unit model. Use the appropriate method to open the stop valves.

- Gas side of RP100-140 (Fig. 4-5)

- Remove the cap, then turn one-quarter rotation counter-clockwise with a flat-bladed screwdriver to complete open.
- Check that the valves are fully open, then return the cap to its original state and tighten it down.

- Liquid side of RP100-140 and Gas/Liquid side of RP35-71 (Fig. 4-6)

- Remove the cap and turn the valve rod counterclockwise as far as it will go with the use of a 4 mm hexagonal wrench. Stop turning when it hits the stopper. ($\phi 6.35$: Approximately 4.5 revolutions) ($\phi 9.52$: Approximately 10 revolutions)
- Make sure that the stop valve is open completely, push in the handle and rotate the cap back to its original position.

Refrigerant pipes are protectively wrapped for RP60-140

- The pipes can be protectively wrapped up to a diameter of $\phi 90$ before or after connecting the pipes. Cut out the knockout in the pipe cover following the groove and wrap the pipes.

Pipe inlet gap for RP60-140

- Use putty or sealant to seal the pipe inlet around the pipes so that no gaps remain. (If the gaps are not closed, noise may be emitted or water and dust will enter the unit and breakdown may result.)

4.6. Addition of refrigerant

- Additional charging is not necessary for this unit if the pipe length does not exceed 30 m.
- If the pipe length exceeds 30 m, charge the unit with additional R410A refrigerant according to the permitted pipe lengths in the chart below.

* When the unit is stopped, charge the unit with the additional refrigerant through the liquid stop valve after the pipe extensions and indoor unit have been vacuumized. When the unit is operating, add refrigerant to the gas check valve using a safety charger. Do not add liquid refrigerant directly to the check valve.

* After charging the unit with refrigerant, note the added refrigerant amount on the service label (attached to the unit). Refer to the "1.5. Using R410A refrigerant air conditioners" for more information.

- Be careful when installing multiple units. Connecting to an incorrect indoor unit can lead to abnormally high pressure and have a serious effect on operation performance.

Model	Permitted pipe length	Permitted vertical difference	Additional refrigerant charging amount			
			31 - 40 m	41 - 50 m	51 - 60 m	61 - 75 m
RP35, 50	-50 m	-30 m	0.2 kg	0.4 kg	—	—
RP60, 71	-50 m		0.6 kg	1.2 kg	—	—
RP100-140	-75 m		0.6 kg	1.2 kg	1.8 kg	2.4 kg

4. Installing the refrigerant piping

4.7. Precautions when reusing existing R22 refrigerant pipes

- Refer to the flowchart below to determine if the existing pipes can be used and if it is necessary to use a filter dryer.
- If the diameter of the existing pipes is different from the specified diameter, refer to technological data materials to confirm if the pipes can be used.
- If the diameter of the existing gas side pipe is bigger than the specified diameter, turn SW8-1 on.

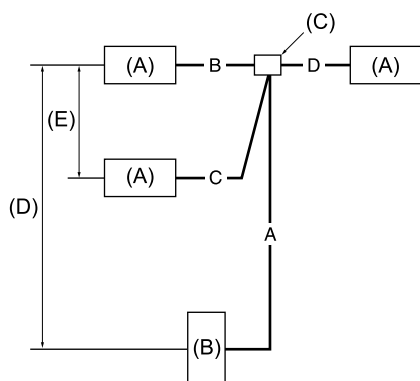
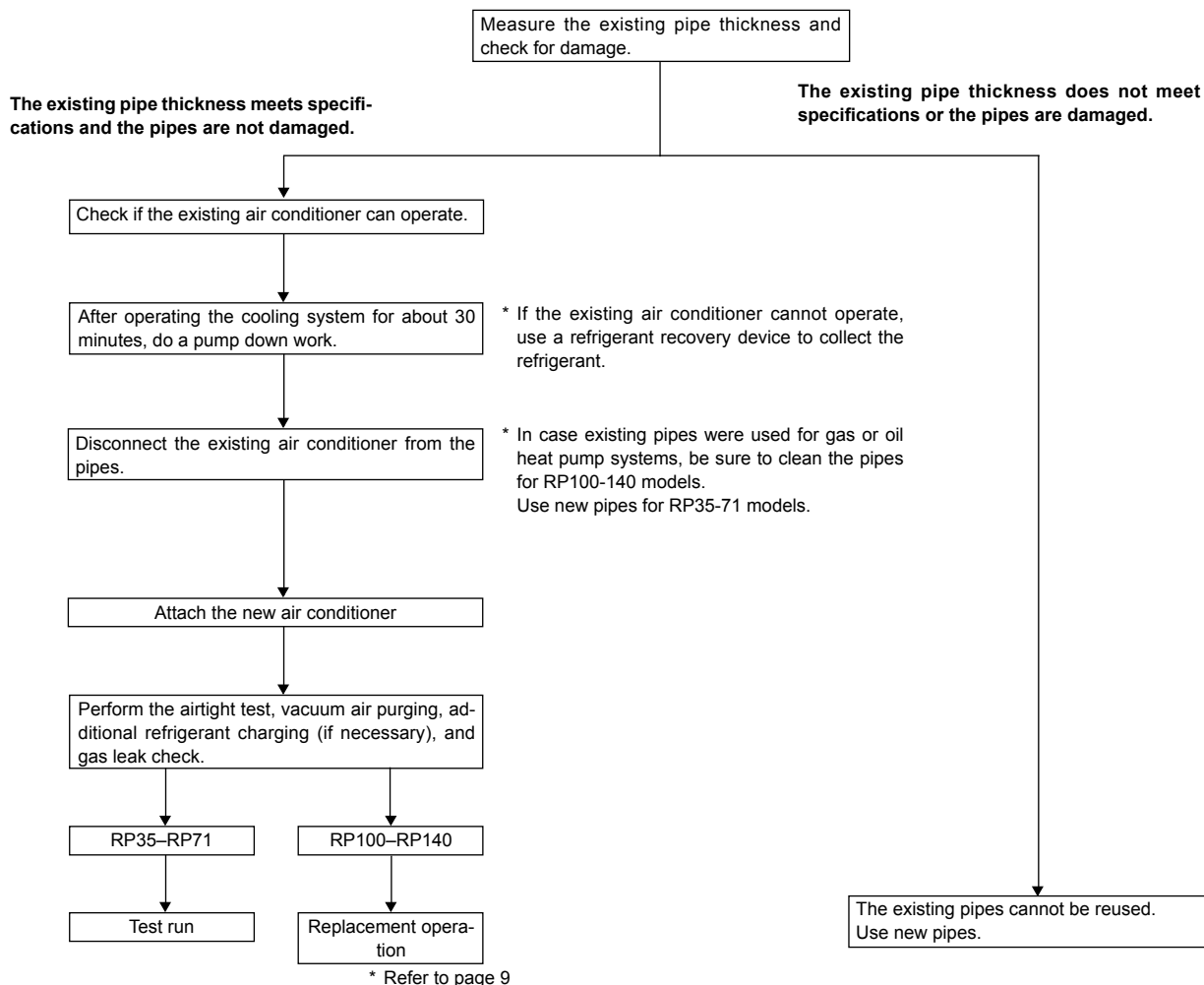

RP71 : $A+B+C \leq 50$
 RP100-140 : $A+B+C+(D) \leq 75$ m

$|B-C|$
 $|B-D|$
 $|C-D|$ } ≤ 8 m

Fig. 4-7

4.8. For twin/triple combination

Refrigerant piping limitation of length, height difference are shown in the figure. (Fig. 4-7)

- (A) Indoor unit
- (B) Outdoor unit
- (C) Multi distribution pipe (option)
- (D) Height difference (Indoor unit-Outdoor unit) Max. 30 m
- (E) Height difference (Indoor unit-Indoor unit) Max. 1 m

5. Drainage piping work

Outdoor unit drainage pipe connection

When drain piping is necessary, use the drain socket or the drain pan (option).

	RP35, 50	RP60-140
Drain socket	PAC-SG61DS-E	
Drain pan	PAC-SG63DP-E	PAC-SG64DP-E

6. Electrical work

6.1. Outdoor unit (Fig. 6-1, Fig. 6-2)

- (1) Remove the service panel.
- (2) Wire the cables referring to the Fig. 6-1 and the Fig. 6-2.

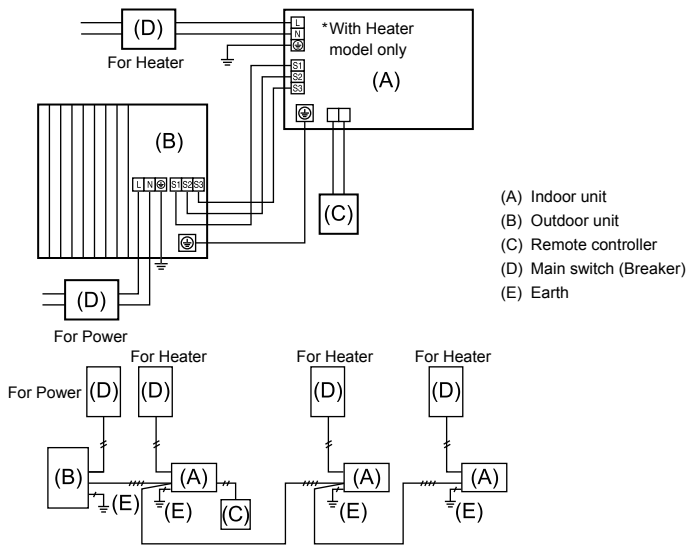

Fig. 6-1

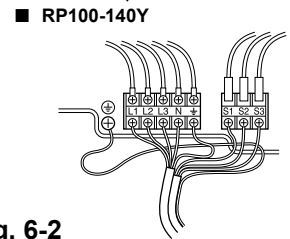
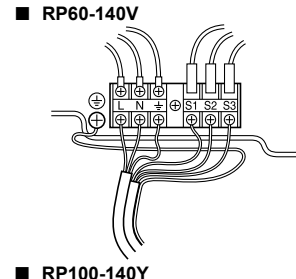
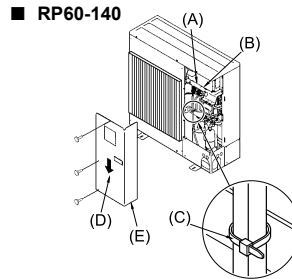
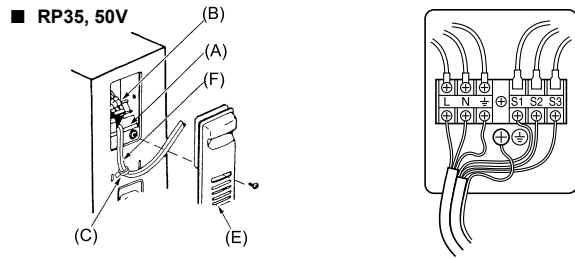

Fig. 6-2

6.2. Field electrical wiring

Outdoor unit model		RP35, 50V	RP60, 71V	RP100, 125V	RP140V	RP100, 125, 140Y
Outdoor unit power supply		~N (single), 50 Hz, 230 V	~N (single), 50 Hz, 230 V	~N (single), 50 Hz, 230 V	~N (single), 50 Hz, 230 V	3N ~ (3phase), 50 Hz, 400 V
Outdoor unit input capacity Main switch (Breaker)		*1				
Outdoor unit power supply		2 × Min. 1.5	2 × Min. 2.5	2 × Min. 4	2 × Min. 6	4 × Min. 1.5
Outdoor unit power supply earth		1 × Min. 1.5	1 × Min. 2.5	1 × Min. 4	1 × Min. 6	1 × Min. 1.5
Wiring Wire No. × size (mm ²)	Indoor unit-Outdoor unit	*2	3 × 1.5 (Polar)	3 × 1.5 (Polar)	3 × 1.5 (Polar)	3 × 1.5 (Polar)
	Indoor unit-Outdoor unit earth	*2	1 × Min. 1.5	1 × Min. 1.5	1 × Min. 1.5	1 × Min. 1.5
Remote controller-Indoor unit		*3	2 × 0.3 (Non-polar)	2 × 0.3 (Non-polar)	2 × 0.3 (Non-polar)	2 × 0.3 (Non-polar)
Circuit rating	Outdoor unit L-N (single)	*4	AC 230 V	AC 230 V	AC 230 V	AC 230 V
	Outdoor unit L1-N, L2-N, L3-N (3 phase)		AC 230 V	AC 230 V	AC 230 V	AC 230 V
	Indoor unit-Outdoor unit S1-S2	*4	AC 230 V	AC 230 V	AC 230 V	AC 230 V
	Indoor unit-Outdoor unit S2-S3	*4	DC 24 V	DC 24 V	DC 24 V	DC 24 V
Remote controller-Indoor unit		*4	DC 12 V	DC 12 V	DC 12 V	DC 12 V

*1. A breaker with at least 3.0 mm contact separation in each poles shall be provided. Use earth leakage breaker (NV).

*2. Max. 45 m

If 2.5 mm² used, Max. 50 m

If 2.5 mm² used and S3 separated, Max. 80 m

*3. The 10 m wire is attached in the remote controller accessory.

*4. The figures are NOT always against the ground.

S3 terminal has DC 24 V against S2 terminal. However between S3 and S1, these terminals are NOT electrically insulated by the transformer or other device.

Notes: (1) Wiring size must comply with the applicable local and national code.

(2) Power supply cords and Indoor/Outdoor unit connecting cords shall not be lighter than polychloroprene sheathed flexible cord. (Design 60245 IEC 57)

(3) Install an earth longer than other cables.

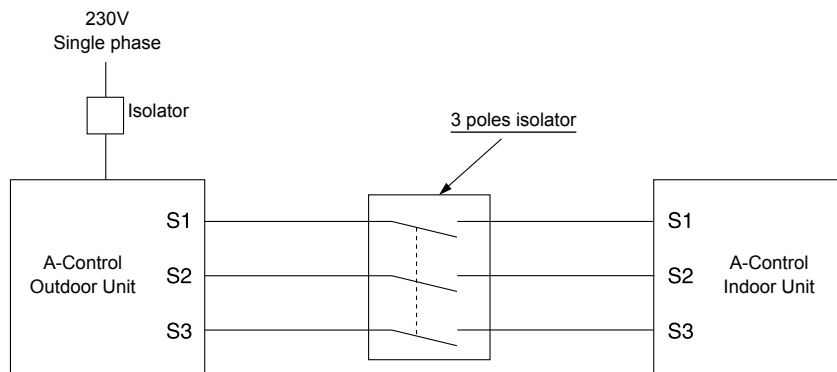

Warning:

In case of A-control wiring, there is high voltage potential on the S3 terminal caused by electrical circuit design that has no electrical insulation between power line and communication signal line. Therefore, please turn off the main power supply when servicing. And do not touch the S1, S2, S3 terminals when the power is energized. If isolator should be used between indoor unit and outdoor unit, please use 3-poles type.

7. Test run

7.1. Before test run

- ▶ After completing installation and the wiring and piping of the indoor and outdoor units, check for refrigerant leakage, looseness in the power supply or control wiring, wrong polarity, and no disconnection of one phase in the supply.
- ▶ Use a 500-volt megohmmeter to check that the resistance between the power supply terminals and ground is at least 1.0 MΩ.
- ▶ Do not carry out this test on the control wiring (low voltage circuit) terminals.

⚠ Warning:

Do not use the air conditioner if the insulation resistance is less than 1.0 MΩ.

Insulation resistance

After installation or after the power source to the unit has been cut for an extended period, the insulation resistance will drop below 1 MΩ due to refrigerant accumulating in the compressor. This is not a malfunction. Perform the following procedures.

- (1) Remove the wires from the compressor and measure the insulation resistance of the compressor.
- (2) If the insulation resistance is below 1 MΩ, the compressor is faulty or the resistance dropped due the accumulation of refrigerant in the compressor.
- (3) After connecting the wires to the compressor, the compressor will start to warm up after power is supplied. After supplying power for the times indicated below, measure the insulation resistance again.

- The insulation resistance drops due to accumulation of refrigerant in the compressor. The resistance will rise above 1 MΩ after the compressor is warmed up for four hours.
(The time necessary to warm up the compressor varies according to atmospheric conditions and refrigerant accumulation.)
 - To operate the compressor with refrigerant accumulated in the compressor, the compressor must be warmed up at least 12 hours to prevent breakdown.
- (4) If the insulation resistance rises above 1 MΩ, the compressor is not faulty.

⚠ Caution:

- The compressor will not operate unless the power supply phase connection is correct.
- Turn on the power at least 12 hours before starting operation.
- Starting operation immediately after turning on the main power switch can result in severe damage to internal parts. Keep the power switch turned on during the operational season.

▶ The following must be checked as well.

- The outdoor unit is not faulty. LED1 and LED2 on the control board of the outdoor unit flash when the outdoor unit is faulty.
- Both the gas and liquid stop valves are completely open.
- A protective sheet covers the surface of the DIP switch panel on the control board of the outdoor unit. Remove the protective sheet to operate the DIP switches easily.

7.2. Unit replacement operation

▶ When reusing existing pipes that carried R22 refrigerant, replacement operation must be performed before performing a test run.

- If new pipes are used, these procedures are not necessary.
- If existing pipes that carried R22 refrigerant are used for RP35-50 models, these procedures are not necessary. (The replacement operation cannot be performed.)

Replacement operation procedures

- (1) Supply power.
- (2) Set DIP switch SW8-2 on the control board of the outdoor unit to ON to start replacement operation.
 - * The replacement operation is performed using the cooling system. Cool air will flow from the indoor unit during the replacement operation.
 - * During the replacement operation, [TEST RUN] is displayed on the remote controller and LED1 and LED2 on the control board of the outdoor unit flash together.
- (3) The duration of the replacement operation is determined by the length of the piping. Always perform the replacement operation for longer than the stipulated time.
 - * Use one of the following methods to complete the replacement operation. When the replacement operation ends, the unit will automatically stop.

- 1) Set SW8-2 from ON to OFF (when ending a replacement operation of less than 2 hours).
 - Because the replacement operation restarts each time SW8-2 is set from OFF to ON, always perform the replacement operation for longer than the stipulated time.

Required replacement operation times

Pipe Length	Replacement Operation Time
0 to 20 meters	30 minutes or more
21 to 30 meters	45 minutes or more
31 to 50 meters	60 minutes or more

- 2) Allow the replacement operation to automatically stop after 2 hours (operation stops while SW8-2 is still in the ON position).
 - When the replacement operation has ended automatically after 2 hours of operation, there is no need to set SW8-2 from ON to OFF; normal air conditioning operation is possible with SW8-2 set to ON. However, to repeat the replacement operation, SW8-2 first has to be set to OFF and then to ON.
 - * If the indoor temperature is less than 15°C, the compressor will operate intermittently but the unit is not faulty.

7.3. Test run

7.3.1. Using SW4 in outdoor unit

SW4-1	ON	Cooling operation
SW4-2	OFF	
SW4-1	ON	Heating operation
SW4-2	ON	

* After performing the test run, set SW4-1 to OFF.

- After power is supplied, a small clicking noise may be heard from the inside of the outdoor unit. The electronic expansion valve is opening and closing. The unit is not faulty.

- A few seconds after the compressor starts, a clanging noise may be heard from the inside of the outdoor unit. The noise is coming from the check valve due to the small difference in pressure in the pipes. The unit is not faulty.

The test run operation mode cannot be changed by DIP switch SW4-2 during the test run. (To change the test run operation mode during the test run, stop the test run by DIP switch SW4-1. After changing the test run operation mode, resume the test run by switch SW4-1.)

7.3.2. Using remote controller

Refer to the indoor unit installation manual.

8. Initial settings for refrigerant leakage detection function

■ Remote control button positions

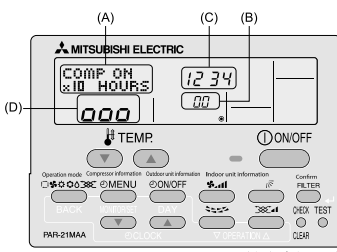

Fig. 8-1

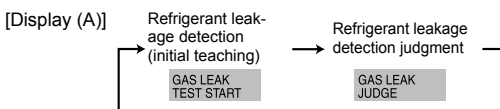

Fig. 8-2

This air conditioner (outdoor unit) can detect refrigerant leakage which may happen during a long period of use. In order to enable the leakage detection, the following settings are required to let the unit memorize the initial conditions (initial learning).

⚠ Caution:

Make sure to perform the "7. Test run" and confirm the unit works without any problems, before starting the following settings.

▶ How to select the "Refrigerant Leakage Detection" mode

Detection is possible regardless the unit's operation (ON or OFF).

- (1) Press [TEST] button for more than three seconds to switch to the maintenance mode.
[Display (A)] MAINTENANCE

▶ How to start the initial learning

- (2) Press [CLOCK] button and select the [GAS LEAK TEST START] (Fig. 8-2)
- * The initial learning for the leakage detection is always done once after the new installation or the data reset.

8. Initial settings for refrigerant leakage detection function

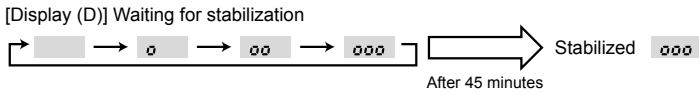

Fig. 8-3

(3) Press **FILTER** (**←**) button to confirm. (Fig. 8-3)

► How to finish the initial learning

Once the unit's operation is stabilized, the initial learning is completed.

(4) Press **TEST** button for more than three seconds to cancel the initial learning. The initial learning can also be cancelled by pressing **ON/OFF** button.

* Refer to the Technical Manual for the refrigerant leakage detection judgment method.

9. Special Functions

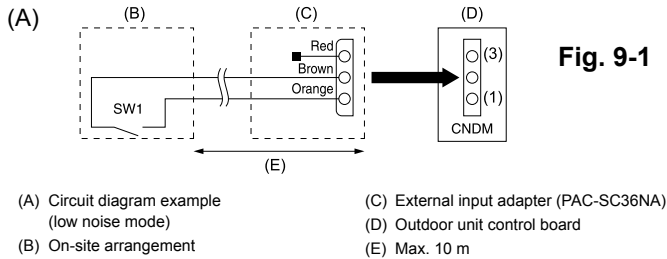

Fig. 9-1

9.1. Low noise mode (on-site modification) (Fig. 9-1)

By performing the following modification, operation noise of the outdoor unit can be reduced by about 3-4 dB.

The low noise mode will be activated when a commercially available timer or the contact input of an ON/OFF switch is added to the CNDM connector (option) on the control board of the outdoor unit.

• The ability varies according to the outdoor temperature and conditions, etc.

(1) Complete the circuit as shown when using the external input adapter (PAC-SC36NA). (Option)

(2) SW1 ON: Low noise mode
SW1 OFF: Normal operation

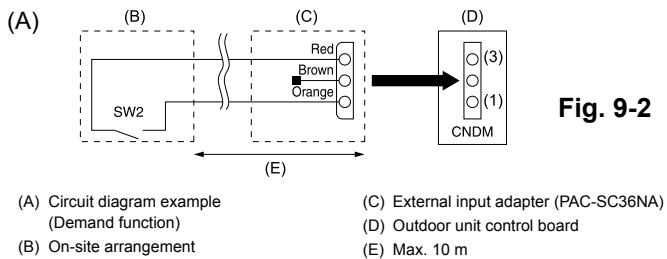

Fig. 9-2

9.2. Demand function (on-site modification) (Fig. 9-2)

By performing the following modification, energy consumption can be reduced to 0-100% of the normal consumption.

The demand function will be activated when a commercially available timer or the contact input of an ON/OFF switch is added to the CNDM connector (option) on the control board of the outdoor unit.

(1) Complete the circuit as shown when using the external input adapter (PAC-SC36NA). (Option)

(2) By setting SW7-1 and SW7-2 on the control board of the outdoor unit, the energy consumption (compared to the normal consumption) can be limited as shown below.

SW7-1	SW7-2	Energy consumption (SW2 ON)
OFF	OFF	0% (Stop)
ON	OFF	50%
OFF	ON	75%

9.3. Refrigerant collecting (pump down)

Perform the following procedures to collect the refrigerant when moving the indoor unit or the outdoor unit.

(1) Supply power (circuit breaker).

* When power is supplied, make sure that "CENTRALLY CONTROLLED" is not displayed on the remote controller. If "CENTRALLY CONTROLLED" is displayed, the refrigerant collecting (pump down) cannot be completed normally.

(2) After the gas stop valve is closed, set the SWP switch on the control board of the outdoor unit to ON. The compressor (outdoor unit) and ventilators (indoor and outdoor units) start operating and refrigerant collecting operation begins. LED1 and LED2 on the control board of the outdoor unit are lit.

* Only set the SWP switch (push-button type) to ON if the unit is stopped. However, even if the unit is stopped and the SWP switch is set to ON less than three minutes after the compressor stops, the refrigerant collecting operation cannot be performed. Wait until compressor has been stopped for three minutes and then set the SWP switch to ON again.

(3) Because the unit automatically stops in about two to three minutes after the refrigerant collecting operation (LED1 and LED2 are lit), be sure to quickly close the gas stop valve. When LED1 and LED2 are lit and the outdoor unit is stopped, open the liquid stop valve completely, and then repeat step (2) after three minutes have passed.

* If the refrigerant collecting operation has been completed normally (LED1 and LED2 are lit), the unit will remain stopped until the power supply is turned off.

(4) Turn off the power supply (circuit breaker).

10. System control (Fig. 10-1)

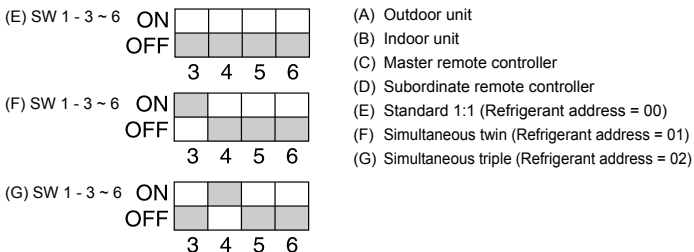

Fig. 10-1

* Set the refrigerant address using the DIP switch of the outdoor unit.

(1) Wiring from the Remote Control

This wire is connected to TB5 (terminal board for remote controller) of the indoor unit (non-polar).

(2) When a Different Refrigerant System Grouping is Used.

Up to 16 refrigerant systems can be controlled as one group using the slim MA remote controller.

Note:

In single refrigerant system (twin/triple), there is no need of wiring (2).

SW1 Function table

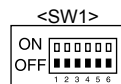

SW1 function settings	Function	Operation according to switch setting	
		ON	OFF
1	Compulsory defrosting	Start	Normal
2	Error history clear	Clear	Normal
3	Refrigerant system address setting	Settings for outdoor unit addresses 0 to 15	
4			
5			
6			

This product is designed and intended for use in the residential,
commercial and light-industrial environment.

The product at hand is based on the following EU regulations:

- Low Voltage Directive 2006/95/ EC
- Electromagnetic Compatibility Directive 89/336/ EEC

Please be sure to put the contact address/telephone number on
this manual before handing it to the customer.